

Optional Power Capacity

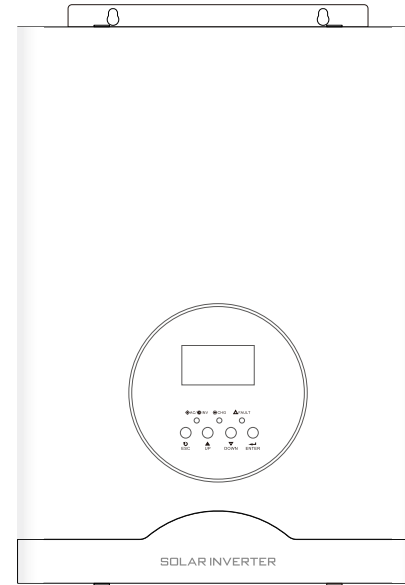

1012/24
1312/24
1512/24
2012/24
3024/48
3824/48
5024/48
6024/48
6324/48
8048
10048
12548

USER MANUAL

UD Series
Inverter/charger

The configuration scheme of the 48V inverter is:

PWM controller: Every 4 PV panels are connected in series into one group, and 10 groups of PV panels are connected .

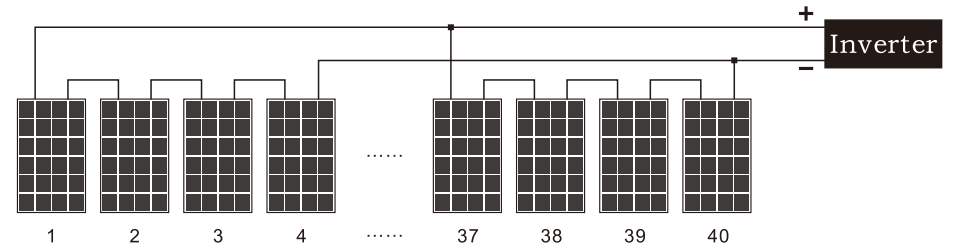

MPPT controller: Every 6 PV panels are connected in series into one group, and 7 groups of PV panels are connected (it can be connected same as PWM).

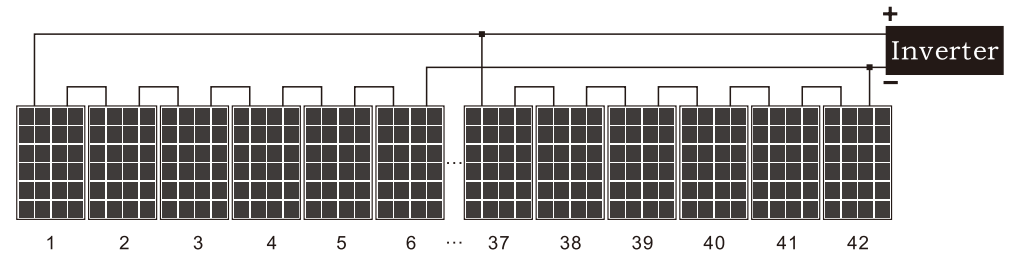

● Daily power generation of solar panels:

Power generation = total solar panel power × controller conversion efficiency × local sunshine average time

The configuration scheme of the 24V inverter is:

PWM controller: every 2 PV panels are connected in series into one group, and 10 groups of PV panels are connected.

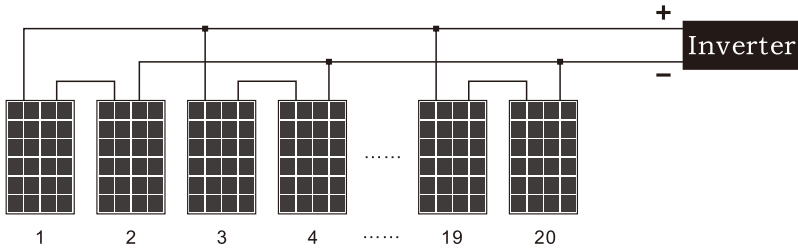

MPPT controller: Every 2 PV panels are connected in series into one group, and 10 groups of PV panels are connected.

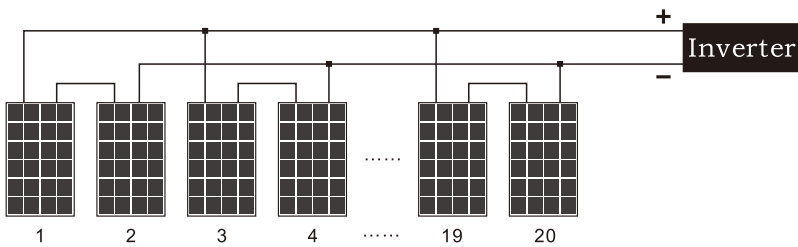

Example 3: Take the 48 V inverter as an example to select the appropriate PV module. Consider that the total Voc of the PV panel cannot exceed the maximum (PWM controller 105 V / MPPT controller 150 V). The total power should be equal to or slightly greater than 3200 W , we can choose the following specifications of PV panels.

Maximum power (Pmax)	80W	The number of PV panels connected in series for each group: PWM→4 PCS (4*21.6V<105V) MPPT→6 PCS (6*21.6V<150V) Total number of PV panels: 40PCS→3200W/80W=40 (PCS) Number of groups that can be connected in parallel: PWM→10groups (40/4 = 10 groups) MPPT →7 groups (40/6 = 7 groups)
Rated voltage Vpm(V)	18V	
Rated current Ipm(A)	4.46A	
Open circuit voltage Voc(V)	21.6V	
Short circuit current Isc(A)	4.8A	

TABLE OF CONTENT

- 1. Safety Instructions..... 1
- 2. Description..... 3
- 3. Operation..... 7
- 4. Installation..... 13
- 5. Troubleshooting 19
- 6. Technical Data..... 20
- 7. Warranty Scope..... 23
- Appendix 24

1. SAFETY INSTRUCTIONS

1.1 General

Please read the manual and all the safety remarks. This product is designed and tested in accordance with international standards. It must be used exclusively for the purpose for which it was designed.



This product is worked with the rechargeable battery. It may still has dangerously voltage in input / output terminals. Please switch the AC and battery power source before carrying out maintenance or servicing the product.

Please call service center. Do not operate the product if any fault. Only Qualified person can undertake all servicing.

Never use the product where there is a risk of gas or dust explosions. (before using) Consult the battery manufacture's to confirm the products if can be used with the battery. Always comply with the battery manufacturer's safety instructions.

1.2 Installation

Read the installation instructions on the manual before installing. This is a Safety Class I product (supplied with a protective grounding terminal) . Uninterruptible protective grounding must be provided at the AC input and output terminals.

It will cause electric shock when the grounding protection has been faulty, please turn off the product.

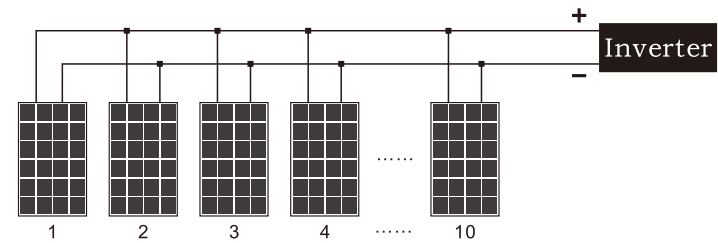

MPPT controller: Every 2 PV panels are connected in series to form a group, and connected to 5 groups of PV panels (also can be connected same as PWM).

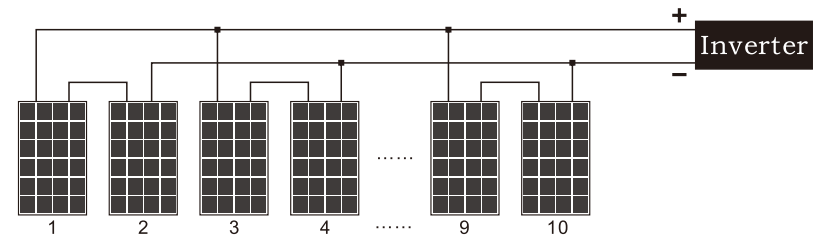

Example 2: Take a 24 V inverter as an example to select suitable PV modules. Consider that the maximum total Voc of PV panels cannot exceed (PWM controller 60 V / MPPT controller 60 V) . The total power should be equal to or slightly greater than 1600 W, we can choose the following specifications of PV panels.

Maximum power (Pmax)	80W	The number of PV panels connected in series for each group: PWM→2 PCS (2*21.6V<60V) MPPT→2 PCS (2*21.6V<60V)
Rated voltage Vpm(V)	18V	
Rated current Ipm(A)	4.46A	Total number of PV panels: 20PCS→1600W/80W=20 (PCS)
Open circuit voltage Voc(V)	21.6V	Number of groups that can be connected in parallel:
Short circuit current Isc(A)	4.8A	PWM→10groups (20/2 = 10 groups) MPPT →10 groups (20/2 = 10 groups)

- In either case, the total output power is the power of a single PV panel × the total number of PV panels. The criteria for configuring PV panels is that the total power should be equal to or slightly greater than the maximum allowable PV power of the solar controller (please refer to the technical parameter table). The excess capacity of PV panels does not contribute to the capacity of solar chargers and will only lead to higher installation costs.
- The total Ipm of the PV panels should be less than the maximum charging current of the inverter (60A) .
- The total Voc of the PV panel should be less than the maximum PV input voltage of the inverter (please refer to the technical parameter table).

Example 1: Take a 12 V inverter as an example to select suitable PV modules. Considering that the total Voc of the PV panel cannot exceed the maximum (PWM controller 30 V / MPPT controller 60 V). The total power should be equal to or slightly greater than 800 W, we can choose the following specifications of PV panels.

Maximum power (Pmax)	80W	The number of PV panels connected in series for each group: PWM→1 PCS (1*21.6V<30V) MPPT→2 PCS (2*21.6V<60V) Total number of PV panels: 10PCS→800W/80W=10 (PCS) Number of groups that can be connected in parallel: PWM→10groups (10/1 = 10 groups) MPPT →5 groups (10/2 = 5 groups)
Rated voltage Vpm(V)	18V	
Rated current Ipm(A)	4.46A	
Open circuit voltage Voc(V)	21.6V	
Short circuit current Isc(A)	4.8A	

The configuration scheme of the 12 V inverter is:

PWM controller: 10 PV panels are connected in parallel to the inverter.

Ensure that the DC and AC Input cables are fuse and the circuit breakers. Never replace the component with different type. Always consult the manual to determine the correct component.

Before connect AC, ensure the power source match to the manual requirement.

Never operate the product in a wet or dusty environment.

Ensure there is adequate free space for ventilation around the product and check that the ventilation vents are not blocked.

Ensure that the application's power consumption not exceed the product's maximum power.

1. 3 Transport and Storage

Ensure that the mains power and battery leads have been disconnected before storing or transporting the product.

No liability can be accepted for any transport damage if the equipment is shipped in non-original packaging.

Store the product in a dry environment, the storage temperature must be between -20°C and 60°C.

Consult the battery manufacturer's manual in respect of transport, storage, charging, recharging and disposal of the battery.

2. Description

Fig. 1 : Inverter

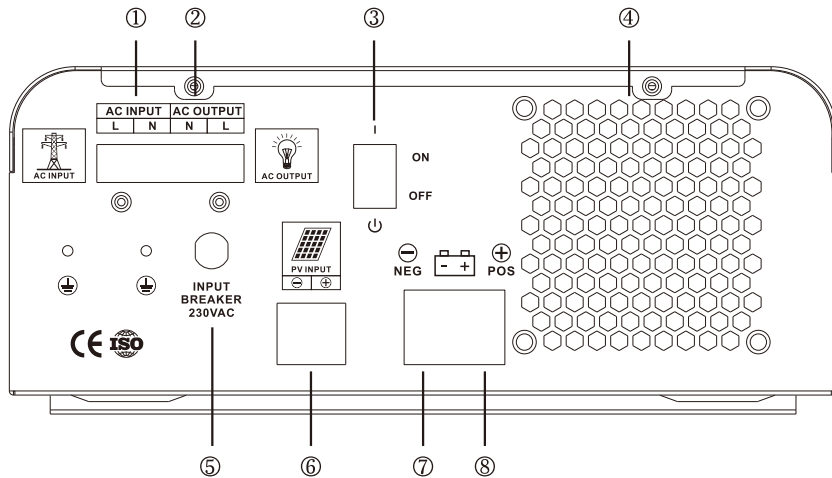

1KVA-1.5KVA

- | | |
|---------------------------|---------------------------------|
| ①.....AC input | ⑤.....Input breaker |
| ②.....AC output | ⑥.....Solar panel input |
| ③.....Power on/off switch | ⑦.....Battery terminal negative |
| ④.....Fan | ⑧.....Battery terminal positive |

Appendix

How to choose and configure PV panels

The following parameters can be found in the specifications of each PV panel:

- Pmax: Maximum output power (W)
- Voc: Open circuit voltage (V)
- Isc: Short circuit current (A)
- Vpm: Rated voltage (V)
- Ipm: Rated current (A)

PV panels can be connected in series or in parallel to obtain the required output voltage and current to meet the allowable range of the solar controller.

When connecting PV panels in series, the total maximum voltage and current are:

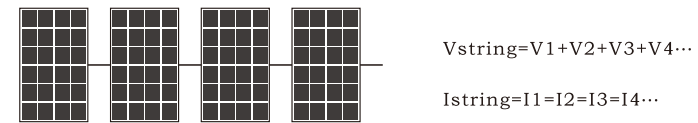

When the PV panels that have been connected in series are connected in parallel, the total maximum voltage and current are:

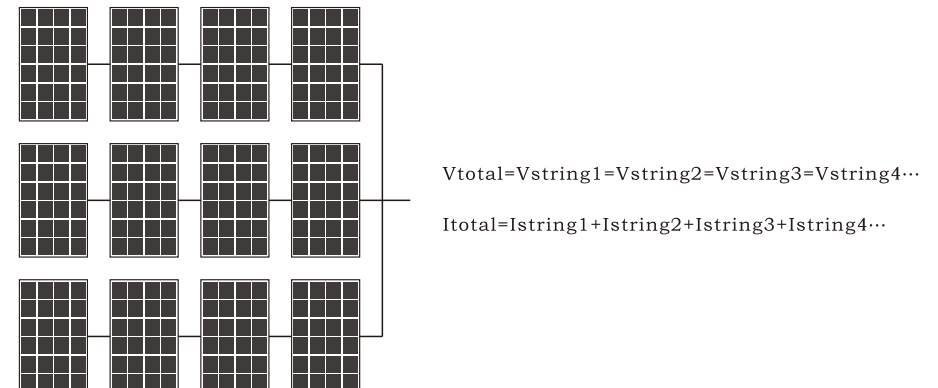

7. Warranty Scope

The following is not within the scope of warranty:

- (a) Battery configured by user.
- (b) Operate not according to the user's manual, resulting in damage to the machine.
- (c) Mechanical damage due to natural disasters such as fire, flood, etc..
- (d) Products beyond the warranty period, provide the paid maintenance service.

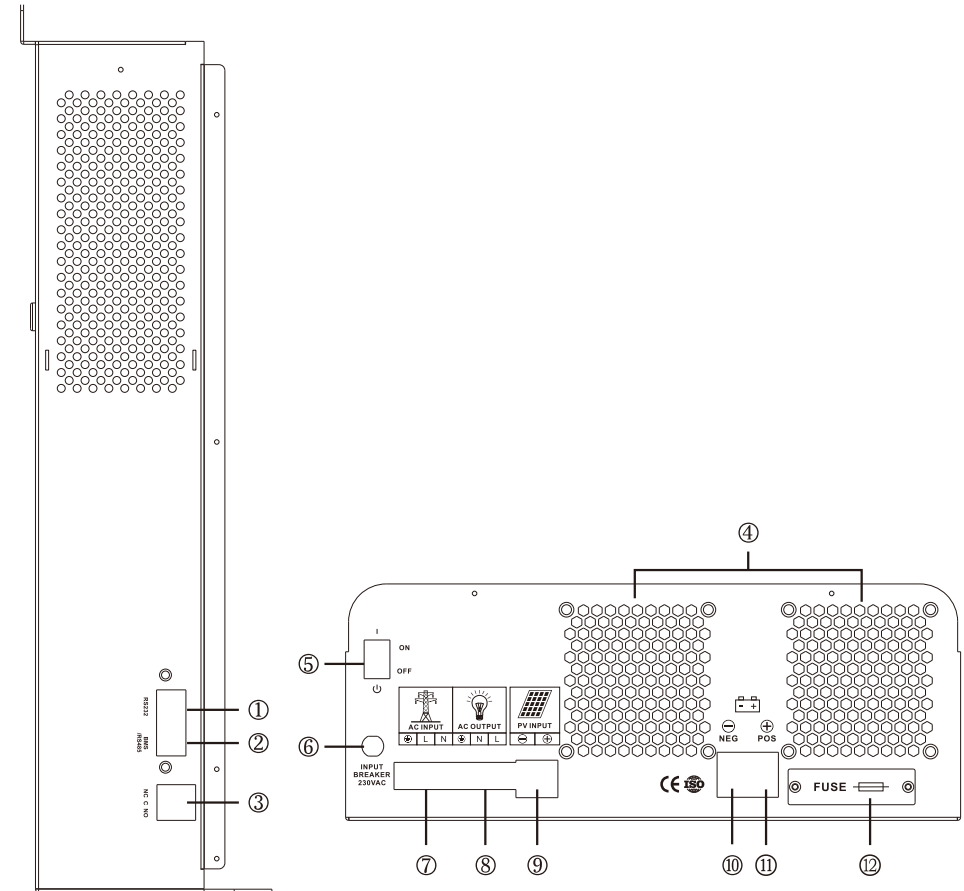

2KVA-5KVA

- | | |
|-----------------------------------|--|
| ①....RS232 communication port | ⑦....AC input |
| ②....BMS/RS485 communication port | ⑧....AC output |
| ③....Dry contact | ⑨....Solar panel input |
| ④....Fan | ⑩....Battery terminal negative |
| ⑤....Power on/off switch | ⑪....Battery terminal positive |
| ⑥....Input breaker | ⑫....FUSE(located under the right fan) |

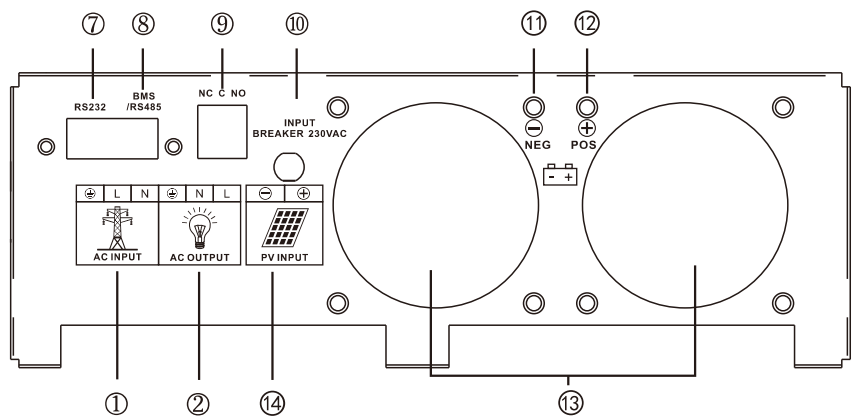
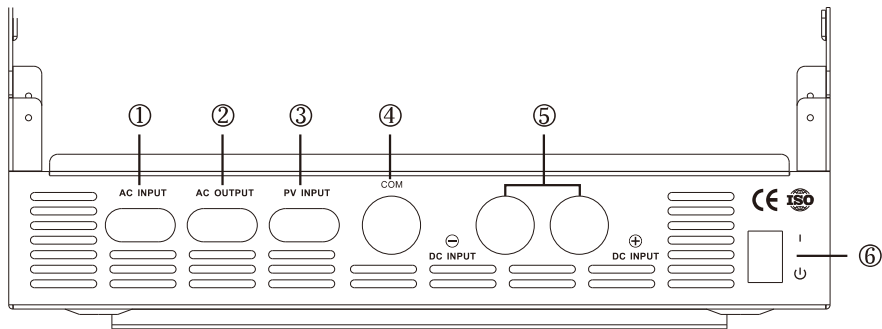

5024-6324

- | | |
|----------------------------|--------------------------------|
| 1.AC input | 8.BMS/RS485 communication port |
| 2.AC output | 9.Dry contact |
| 3.PV input | 10.Input breaker |
| 4.Communication port | 11.Battery terminal negative |
| 5.Battery input | 12.Battery terminal positive |
| 6.Power ON/OFF switch | 13.Fan |
| 7.RS232 communication port | 14.Solar panel input |

TECHNICAL DATASHEET(6~12.5K)

MODEL	6048	6348	8048	10048	12548
Input					
Capacity (VA)	6000VA	6300VA	8000VA	10000VA	12500VA
Voltage (DC)	48V	48V	48V	48V	48V
Nominal Voltage	220VAC/110VAC				
Voltage Range	154-264VAC/77-132VAC				
Frequency	50-60Hz Auto sensing				
Output					
Watt	4800W	5000W	6400W	8000W	10000W
Voltage	220VAC/110VAC				
Frequency	50/60Hz				
Waveform	Pure sinewave				
Transfer time(AC to DC)	<8ms				
Transfer time(DC to AC)	<8ms				
Output voltage regulation	10%rms				
Bypass Mode	Yes				
Saver Mode	Yes				
Efficiency	>98%				
Protection					
Input Protection	Circuit Breaker				
Output Protection	Circuit Breaker				
Battery					
Battery Type	AGM-Deep Cycle,GEL				
	Up to 500Ah				
Charging current	29A	29A	39A	50A	60A
Low Level disconnect(Selectable)	48V:(40V or 42V)				
LCD Indicator status	Input AC,Output AC				
	Battery DC,Output Load				
	Alarm,Fault				
LED Indicator status	Battery Charge Level				
	Output Frequency				
	AC Line In:Green				
Battery low alarm	Inverter:Green				
	Charging:Yellow				
	Alarm:Red				
Battery low alarm	48V:battery light discharge 46V; battery load discharge 46V@load<20% ; 44V@load>50%/42V@load>50%;				
Battery low recovery	48V:battery light discharge 48V ; battery load discharge 48V@load<20% ; 46V@load>50%/44V@load>50%;				
DC low voltage shutdown	48V:battery light discharge 44V ; battery load discharge 44V@load<20% ; 42V@load>50%/40V@load>50%;				
DC high voltage alarm and fault	64V				
DC high voltage recovery	60V				
Maximum PV array power	48V:6400W				
MPPT/PWM input voltage range	48V:MPPT60-150VDC(or PWM60VDC-105VDC)				
Maximum PV array open circuit voltage	48V:MPPT150VDC(or PWM105VDC)				
Maximum solar charging current	120A				
Alarm					
Low battery alarm	Audible alarm-1 beeping per second				
Overload alarm	Audible alarm-continuous beeping				
Fault	Audible alarm-continuous beeping				
Environment					
Temperature	0-40°C				
Humidity	C0-95 % Non condensing				
Accoustic Noise(db)	<45dB				

Maximum PV array power	12V:800W 24V:1600W 48V:3200W
MPPT/PWM input voltage range	12V:MPPT15-150VDC(or PWM15VDC-50VDC) 24V:MPPT30-150VDC(or PWM30VDC-105VDC) 48V:MPPT60-150VDC(or PWM60VDC-105VDC)
Maximum PV array open circuit voltage	12V:MPPT150VDC(or PWM50VDC) 24V:MPPT150VDC(or PWM105VDC) 48V:MPPT150VDC(or PWM105VDC)
Maximum solar charging current	60A
Alarm	
Low battery alarm	Audible alarm-1 beeping per second
Overload alarm	Audible alarm-continuous beeping
Fault	Audible alarm-continuous beeping
Environment	
Temperature	0-40°C
Humidity	C0-95 %, Non condensing
Accoustic Noise(db)	<45dB

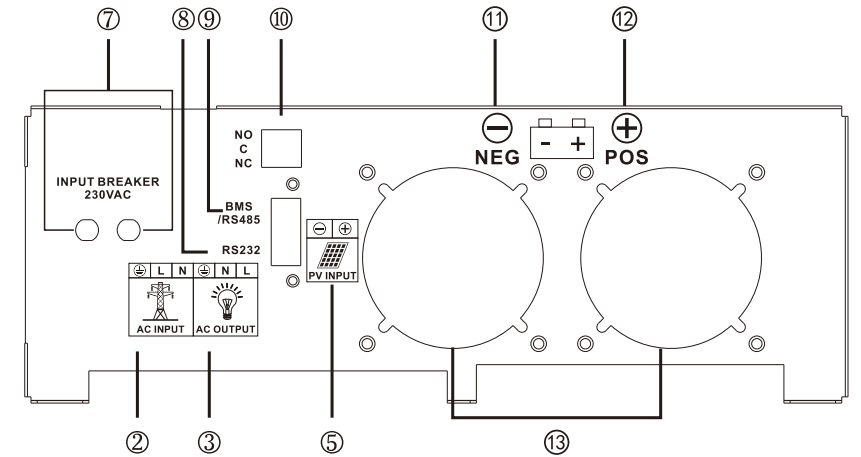
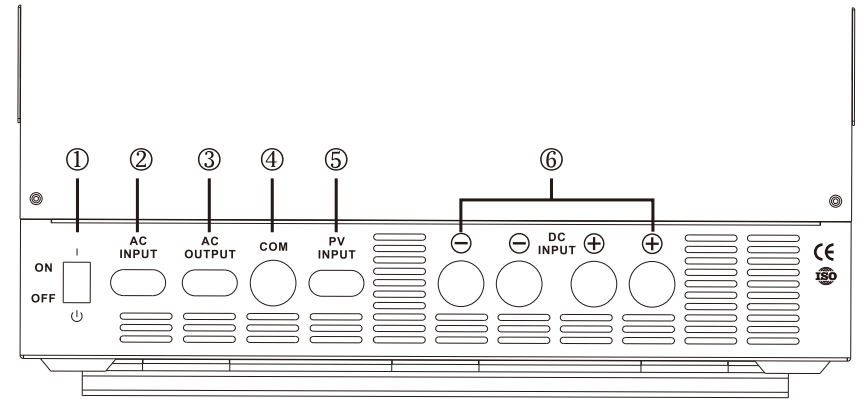

6KVA-12.5KVA

- | | |
|-----------------------|--------------------------------|
| 1.Power ON/OFF switch | 8.RS232 communication port |
| 2.AC input | 9.BMS/RS485 communication port |
| 3.AC output | 10.Dry contact |
| 4.Communication port | 11.Battery terminal negative |
| 5.PV input | 12.Battery terminal positive |
| 6.Battery input | 13.Fan |
| 7.Input breaker | |

Fig 2 : LCD SCREEN

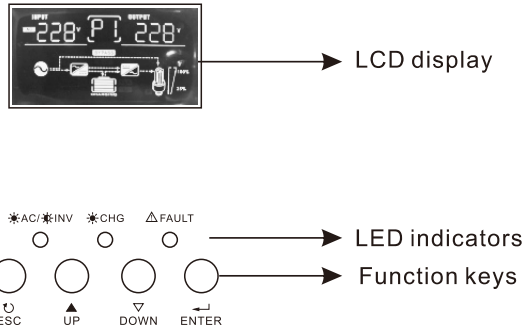

LED INDICATOR

LED Indicator		Messages	
☀️ AC/🌞 INV	Green	Solid On	Output is powered by utility in Line mode.
		Flashing	Output is powered by battery or PV in battery mode.
🔋 CHG	Yellow	Solid On	Battery is fully charged.
		Flashing	Battery is charging.
⚠️ FAULT	Red	Solid On	The inverter is in the fault warning status.

Function Keys

Function Key	Description
ESC	To exit setting mode
UP	To go to previous selection
DOWN	To go to next selection
ENTER	To confirm the selection in setting mode or enter setting mode

3. OPERATION

3.1 AC Mode

Switch on the power button, the product is fully functional, the green LED "AC In" will light up.

6. TECHNICAL DATASHEET(1-6.3K)

MODEL	1012/24	1312/24	1512/24	2012/24	3024/48	3824/48	5024/48	6024	6324
Input									
Capacity (VA)	1000VA	1300VA	1500VA	2000VA	3000VA	3800VA	5000VA	6000VA	6300VA
Voltage (DC)	12/24V	12/24V	12/24V	12/24V	24/48V	24/48V	24/48V	24V	24V
Nominal Voltage	220VAC/110VAC								
Voltage Range	154-265VAC/77-135VAC								
Frequency	50-60Hz Auto sensing								
Output									
Watt	800W	1000W	1200W	1600W	2400W	3000W	4000W	4800W	5000W
Voltage	220VAC/110VAC(± 10% ups mode)								
Frequency	50/60Hz								
Waveform	Pure sinewave								
Transfer time(AC to DC)	<8ms								
Transfer time(DC to AC)	<8ms								
Output voltage regulation	10%rms								
Bypass Mode	Yes								
Saver Mode	Yes								
Efficiency	>98%								
Protection									
Input Protection	Circuit Breaker								
Output Protection	Circuit Breaker								
Battery									
Battery Type	AGM-Deep Cycle,GEL,LIFEPO4								
	Up to 500Ah								
Charging current	20/10A	25/13A	30/15A	35/18A	30/15A	35/18A	40/20A	58A	58A
Low Level disconnect(Selectable)	12V:(10V or 10.5V) 24V:(20V or 21V) 48V:(40V or 42V)								
LCD Indicator status	Input AC,Output AC								
	Battery DC,Output Load								
	Alarm,Fault								
	Battery Charge Level								
LED Indicator status	Output Frequency								
	AC Line In:Green								
	Inverter:Green								
	Charging:Yellow								
Battery low alarm	Alarm:Red								
	12V:battery light discharge 11.5V; battery load discharge 11.5V@load<20% ; 11V@load>50%/10.5V@load>50% ; 24V:battery light discharge 23V; battery load discharge 23V@load<20% ; 22V@load>50%/21V@load>50% ; 48V:battery light discharge 46V; battery load discharge 46V@load<20% ; 44V@load>50%/42V@load>50% ;								
	12V:battery light discharge 12V ; battery load discharge 12V@load<20% ; 11.5V@load>50%/11V@load>50% ; 24V:battery light discharge 24V ; battery load discharge 24V@load<20% ; 23V@load>50%/22V@load>50% ; 48V:battery light discharge 48V ; battery load discharge 48V@load<20% ; 46V@load>50%/44V@load>50% ;								
	12V:battery light discharge 11V ; battery load discharge 11V@load<20% ; 10.5V@load>50%/10V@load>50% ; 24V:battery light discharge 22V ; battery load discharge 22V@load<20% ; 21V@load>50%/20V@load>50% ; 48V:battery light discharge 44V ; battery load discharge 44V@load<20% ; 42V@load>50%/40V@load>50% ;								
DC low voltage shutdown									
DC high voltage alarm and fault	16V/32V/64V								
DC high voltage recovery	15V/30V/60V								

Tab.II

Models	DC Rating (Volts)	Minimum Batteries	Maximum Batteries
1012/24	12/24	1/2	3/6
1312/24	12/24	1/2	3/6
1512/24	12/24	1/2	3/6
2012/24	12/24	1/2	3/6
3024/48	24/48	2/4	6/8
3824/48	24/48	2/4	6/8
5024/48	24/48	2/4	6/8
6024/48	24/48	2/4	6/8
6324/48	24/48	2/4	6/8
8048	48	4	12
10048	48	4	16
12548	48	4	16

5. TROUBLESHOOTING

Proceed as follows for quick detection of common faults. DC loads must be disconnected from the batteries and the AC loads must be disconnected from the inverter before the inverter and/or battery charger is tested.

Consult your local dealer/repair center if the fault cannot be resolved.

Note: If the fuse is burnt due to the reverse connection of the battery or overcurrent, please remove the right fan and replace the fuse. Please make sure the power supply of the machine is completely disconnected before replacing.

Tab.III

Problem	Cause	Solution
The inverter fails to operate when switched on	Battery terminal not firm	Tighten the battery terminals.
Continuous spark from the inverter terminal	Battery terminal reversal	Check and connect the cable to the right terminal lead.
No output from inverter	Output cable terminals loosed	Open the casing and connect the output cable terminals firm to the appropriate lead.
Inverter not charging battery	input power less than(<) 150VAC	A step-up stabilizer of rating higher than the inverter should be installed.
Continuous alarm when the inverter is loaded	Overloading condition	Check the loads and disconnect heavier loads.

3.2 Inverter Mode

When electricity off or generator power being disconnected, it will transfer to inverter mode. The transfer time is less than 10 milliseconds so that computers and other electronic equipment will continue to operate without disruption. The green LED light of "Inverter" will light up.

3.3 Charging Mode

When electricity recovery or generator power on the green LED "AC In" comes up and the orange "Charge" light starts blinking. When the batteries are fully charged, the blinking orange light changes to Solid Orange.

3.4 Alarm Mode

When battery discharge and it gets close to the battery cutoff voltage, the red "Alarm" light starts showing with a continuous beeping sound, if the electricity not recovery, it will keep this status until the battery reaches the low voltage cut-off point and shut down automatically .

3.5 Bypass Mode

The product's power button is off. but the electricity or generator on, it has output to load meanwhile charging the battery. When the power button is off, if without electricity or generator off, there will be no output to load.

3.6 Saver Mode

If there is no supply of grid, the inverter's AC output will not be supplied until a load greater than 15 watts is connected to the inverter. It automatically detects the connected load every 25 seconds.

3.7 Setting Mode/Error Codes for reference

Enter setting mode, Press "ENTER" button for 10 seconds.

Exit setting mode, Press "ESC" button repeatedly.

1. Press "UP" or "DOWN" button to choose the parameter and then press "ENTER" button.

2. When parameter is flashing, press "UP" or "DOWN" to change it and then press "ENTER" button to confirm.

When setting: Setting icon is flashing

Setting succeed: Left-sided frame of the parameter will flash

Setting failed: FAULT light on

Settings	Display (Left)	Display (Mid)	Display (Right)	Setting range	Descriptions
Mains input voltage range	Alr	00	UPS	Narrow range	Mains input range is 180-265V
			APL	Wide range	Mains input range is 155-265V
Mains frequency oltage range	AFr	01	LO	Narrow range	Mains input frequency range is 45-65HZ
			HI	Wide range	Mains input frequency range is 40-70HZ
Working mode	None	02	UTI	Mains priority	The utility power will provide power to the load first. Only when the utility power is not enough to supply the load, the solar energy And the battery will provide power to the load.
			SOL	Solar priority	When solar energy is sufficient, solar energy will be preferentially provided to the load. When there is solar energy but not enough, the solar energy and battery power will provide power to the load at the same time. When there is no solar power, the utility will provide power to the load. At the same time, If the battery voltage drops to the low-battery warning voltage point or the set DC-to-AC voltage point, the mains will also provide power to the load.
			SBU	Battery priority	When solar energy is sufficient, solar energy will be preferentially provided to the load. When there is solar energy but not enough, the solar energy and battery power will provide power to the load at the same time. If the battery voltage drops to the low battery warning voltage point or the set DC to AC voltage point, the mains will provide power to the load.
Charging mode	None	03	CUT	Mains priority	The energy of the mains and the solar energy charge the battery at the same time
			CSO	Solar priority	In the solar priority mode, when the PV meets the requirements, the battery is charged with solar energy preferentially, and when the battery voltage is too low, the mains charge will be started
			OSO	Solar charging only	The machine simply uses the energy of solar energy to charge the battery
Mains charging current ratio	ACP	04	100%	10~100%	Adjustable charging current ratio of mains
Solar charging current ratio	SCP	05	100%	20~100%	You can adjust the charging current proportional solar

12 volts Battery in Series

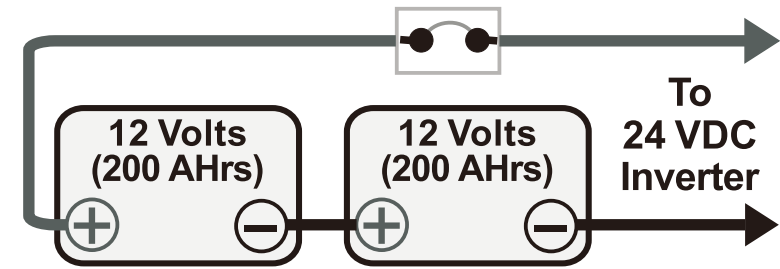

24 Volts battery (total capacity=200 Ah)

Fig 6. Parallel Battery Wiring

Difference between Series and Parallel connection

Batteries in Parallel

Voltage remain the same
Ah capacity doubles

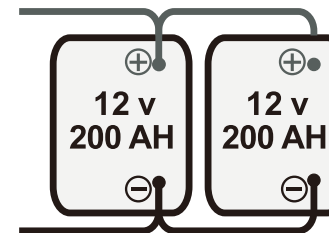

System Voltage = 12Volts
Ah Capacity = 400AH

Batteries in Series

Voltage doubles
Ah capacity stays the same

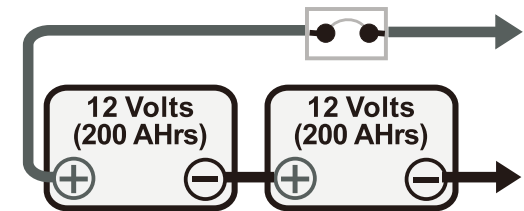

System Voltage=24V
Ah Capacity=200AH

Tab.I

Models	Minimum DC Wire Size(rating)	Maximum DC Fuse size	DC Grounding wire size
1012/24	16/8mm ²	100/50A	2.5mm ²
1312/24	25/16mm ²	160/80A	2.5mm ²
1512/24	25/16mm ²	160/80A	2.5mm ²
2012/24	32/16mm ²	200/100A	2.5mm ²
3024/48	25/16mm ²	150/80A	2.5mm ²
3824/48	32/16mm ²	200/100A	2.5mm ²
5024/48	50/25mm ²	250/160A	2.5mm ²
6024/48	50/25mm ²	300/160A	4.0mm ²
6324/48	50/25mm ²	300/160A	4.0mm ²
8048	35mm ²	200A	4.0mm ²
10048	50mm ²	250A	4.0mm ²
12548	60mm ²	300A	4.0mm ²

4.3.3 Parallel and Series Connection

12 Volts Battery In Parallel

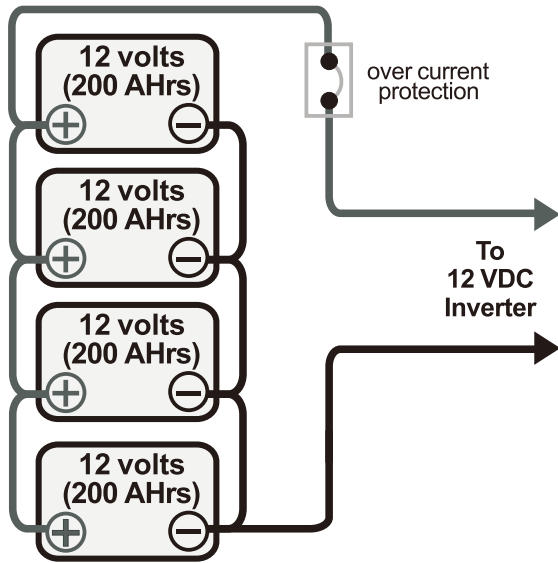

12 volt battery (total capacity=800 Ah)

Fig 5. Parallel Battery Wiring

Settings	Display (Left)	Display (Mid)	Display (Right)	Setting range	Descriptions
Boost charging voltage	CU	06	14.2V	13.5~15.0V	Bulk charging voltage setting, according to different types of batteries
			28.4V	27.0~30.0V	
			56.8V	54.0~60.0V	
Float charging voltage	FLU	07	13.6V	12.5~14.0V	Float voltage setting, according to different types of batteries
			27.2V	25.0~28.0V	
			54.4V	50.0~56.0V	
Battery lockdown voltage	COU	08	10.2V	9.5~11.5V	Set the shutdown voltage point of battery protection voltage
			20.4V	19.0~23.0V	
			40.8V	38.0~46.0V	
Charging voltage of mains recovery	DTA	09	12.0V	11.5~12.5V	Set the battery voltage point when the mains power is involved in the solar energy priority charging mode
			24.0V	23.0~25.0V	
			48.0V	46.0~50.0V	
Charging voltage of mains off	ATD	10	13.5V	13.0~14.0V	Select the voltage point of converting from mains to solar power in solar priority mode
			27.0V	26.0~28.0V	
			54.0V	52.0~56.0V	
Inv. output voltage	OU	11	220V	200~240V	Set the inverter output voltage
Mains detection speed	CST	12	HI	High speed	Mains sensitivity settings: high medium low
			IDE	Mid. speed	
			LO	Low speed	
Inv. output frequency	OF	13	50Hz		Set inverter output frequency
			60Hz		
Fault restart switch	RA	14	TE	On	Restart 3 times after short circuit or overload
			TD	Off	No restart after short circuit or overload
Backlight control	BLC	15	LON	Always on	The display backlight is always on
			LOF	Always off	The display backlight is always off
			LOD	Delay off	Display backlight smart switch
Buzzer control switch	BEC	16	AON	On	Allows beeping in fault state
			AOF	Off	No beeping in any state
Low battery alarm switch	BOL	17	OFF	Off	Intelligent battery protection function, it is not recommended to change
			ON	On	
Load limit	LL	18	OFF	Off	Intelligent transformer temperature protection function, it is not recommended to change
			ON	On	
Load alarm limit	LEL	19	OFF	Off	This setting does not adapt to this inverter. Setting not available.
			ON	On	
Baud rate	BAU	20	0	2400	Set the communication baud rate
			1	4800	
			2	9600	
Output display mode	ODT	21	220V	220V	Set display output voltage
			110V	110V	
Swon bat voltage	BLS	22	11.5V	10.5~12.2V	After the machine is shut down abnormally, the battery voltage must be higher than the set value before it can be turned on normally
			23.0V	21~24.4V	
			46.0V	42~48.8V	

Settings	Display (Left)	Display (Mid)	Display (Right)	Setting range	Descriptions
Bat low off restart vol	BRU	23	13.0V	12.0~14.0V	After the machine is shut down abnormally, the battery voltage must be higher than the set value before it can be turned on normally
			26.0V	24.0~28.0V	
			52.0V	48.0~56.0V	
Battery type	BTT	24	SEL	SEL	Sealed Lead Acid Battery
			GEL	GEL	Gel Battery
			FLD	FLD	Inter Cell
			USER	USER	Customer Customization
			TER	LiCoMnNiO2	Ternary Lithium Battery
			LIF	BAT-LiFePO4	Lithium Iron Phosphate Battery
BMS Function Switch	BnS	25	OFF	On Off	Whether to enable the BMS communication function
Bat Soc Under Lock	BSU	26	10%	5~50%	BMS low voltage SOC value, if the BMS SOC value is lower than the set value, the inverter will shut down to protect the battery
Bat Soc Turn To Ac	STG	27	20%	5~50%	When the working mode of the inverter is set to the battery priority mode, the inverter will be forced to enter the mains charging when the SOC of the BMS is lower than the set value.
Bat Soc Turn To Dc	STB	28	95%	50~100%	When the working mode of the inverter is set to the battery priority mode, the inverter resumes the DC working mode when the SOC of the BMS is higher than the set value.
Bat Restart Soc	BSR	29	50%	30~100%	When the inverter is turned on, the SOC must be higher than the set value to work normally.
Factory Reset	RS	None	OFF	On	All settings are restored to factory settings
				Off	No recovery process, keep existing settings
ECO Mode	ECO	None	OFF	On	ECO mode switching
				Off	

When the BMS/485 communication interface is externally connected, as shown in the following figure:

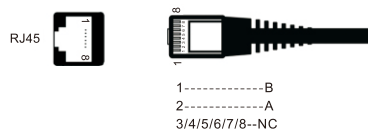

The DC over current device (i.e., fuse or circuit breaker) must be placed in the positive (RED) DC cable line between the inverter's positive DC terminal and the battery's positive terminal (RED); as close to the battery as possible.

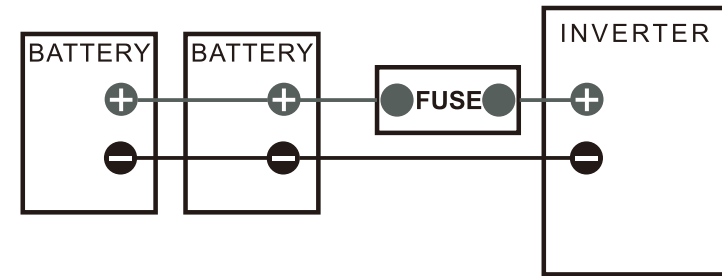

Fig 4:Inline fuse

A brief spark or arc may occur when connecting the battery cables to the inverter DC terminals; this is normal and due to the inverter's internal capacitors being charged.

All wiring to the battery terminals should be checked periodically (once a month) for proper tightening

Secure the nuts tightly in order to reduce the contact resistance as much as possible.

Be aware that over-tightening or misthreading the nuts on the DO terminals can cause the bolts to strip and snap/break off.

4.3.2 DC Wiring Size

It is important to use the correct sized DC wire to achieve maximum efficiency from the system and to reduce fire hazards associated with overheating. Always keep your wire runs as short as practical to prevent low voltage shutdowns and to keep the DC breaker from nuisance tripping (or open fuses) because of increased current draw. The correct minimum DC wire size (and corresponding over current device) is required in order to reduce stress on the inverter minimize voltage drops. increase system efficiency and ensure the inverter's ability to surge heavy loads.

If the distance from the inverter to the battery bank is <5 feet. use a minimum DC wire size of #2 AWG (33.6 mm²). If the distance between the inverter and the battery is >5 feet. the DC wire will need to be increased. Longer distances cause an increase in resistance. which affects the performance of the inverter.

AC Safety Grounding: During the AC wiring installation, AC input and output ground wires are connected to the product. The AC input ground wire must connect to the incoming ground from your AC utility source. The AC output ground wire should go to the grounding point for your applications.

4.3 DC Wiring:

 WARNING
<p>DO NOT connect the DC wires from the battery bank to the inverter until:</p> <ul style="list-style-type: none"> • All AC wiring is complete, • The correct DC and AC protection switches are OFF • The correct DC voltage and polarity have been verified

Depending upon the type of batteries you use in the installation (6 or 12VDC), the batteries must be wired in series, parallel, or series-parallel. The interconnecting DC wires must be sized and rated exactly the same as those used between the battery bank and the products.

To ensure the best performance from your inverter system, do not use old or untested batteries. Batteries should be of the same size, type, rating and age.

4.3.1 Procedure

The battery's Ampere Hour bigger, the back up time longer, and the battery connects wire should be corresponding.

Please follow below connect the battery cables:

 WARNING
<ul style="list-style-type: none"> • Use an insulated box spanner in order to avoid shorting the battery. • Avoid shorting the battery cables.

Connect the battery cables: the + (red) on the left and the-(black) on the right,to the battery. Reverse polarity connection (+ to - and - to +) will cause damage to the product.(Safety fuse inside the Inverter unit can be damaged)

Communication Connection

Please use supplied communication cable to connect to inverter and PC. Please install a monitoring software on the computer.

Dry Contact Signal

There is one dry contact (3A/250VAC) available on the rear panel.It could be used to deliver signal to external device when battery voltage reaches warning level.

Unit Status	Condition		Dry contact port: 		
			NC & C	NO & C	
Power Off	Unit is off and no output is powered.		Close	Open	
Power On	Output is powered from battery or solar.	Normal mode	Battery voltage < Low DC warning voltage	Open	Close
			Battery voltage > Float charging voltage	Close	Open
		Solar first mode	Battery voltage < Solar to AC voltage	Open	Close
			Battery voltage > AC to DC voltage	Close	Open

Error Codes for reference

Display (Left)	Display (Right)	Details
ALA	021	Inverter communication connection failure alarm
ALA	233	Abnormal mains output alarm
ALA	236	Abnormal machine load alarm
ALA	237	Inverter overload alarm
ALA	231	Abnormal output alarm
ALA	234	High battery voltage alarm
ALA	235	Low battery voltage alarm
ALA	241	Memory chip read and write error alarm
ALA	232	Memory chip connection failure alarm
ALA	238	Inverter over temperature alarm
ALA	239	Load-causing over temperature alarm
ALA	242	Host computer software planned shutdown alarm

ALA	244	BMS other faults
ALA	245	BMS communication abnormal
ALA	246	BMS charging overcurrent
ALA	247	BMS discharge overcurrent
ALA	248	BMS High Temperature
ALA	249	BMS Low Temperature
FAL	102	Inverter overload shutdown fault
FAL	104	Abnormal output fault
FAL	105	Abnormal load fault
FAL	106	Inverter over temperature fault
FAL	135	High battery voltage fault
FAL	134	Low battery voltage fault
FAL	123	Load-causing over temperature fault
FAL	169	Current detection signal failure
FAL	161	Abnormal mains output fault
FAL	152	Temperature sensor connection failure
FAL	162	Host computer software planned shutdown failure

4. INSTALLATION



4.1 Locating and Mounting the Inverter

The product must be installed in a dry and well-ventilated area, as close as possible to the batteries. There should be a clear space of at least 10cm for cooling.

High temperature will result following issue:

- Reduced product serving life.
- Reduced charging current.
- Reduced peak capacity, or shutdown of the inverter.

Never mount the appliance directly above the batteries. The product is suitable for wall mounting. The appliance can be mounted horizontally as well as vertically; vertical mounting is preferable. The vertical position offers optimum cooling.

After installation, keeping the air circulating inside the product. In order to minimize the losses of cable voltage, keep the suitable distance between the product and battery.

For safety purposes this product should be installed in a well ventilated place, keep it away from chemicals synthetic components curtains or other textiles, etc.

4.2 AC Wiring

This is a Safety Class I product (supplied with a protective grounding terminal). Uninterruptible protective grounding must be provided at the AC input and/output terminals.

AC Wiring should be connected with following order:

- AC INPUT (Source)
- AC OUTPUT (Load)



Fig 3: AC input/Output Connections

AC Input: The product has Input protection circuit breaker. This should be switched off before the wiring connection.

Remove the AC wiring compartment cover to connect AC terminal, include grounding L and N to the corresponding terminal.

AC Output: The product has output protection circuit breaker. It should be switched off before the wiring connection. When connect the AC OUTPUT wiring, it should be connected the corresponding terminal.

After wiring, double check and review all connections to make sure the wires are in the correct terminals and the terminals are tight.